

**A “STONE SET TECHNOLOGY” PRODUCT**

**US PATENT NUMBER 6668584**

**U N I L O C K**

**(THE ULTIMATE JEWELRY ELEMENT OF PERSONALIZATION)**

**UNILOCK “U” FLUSH INTO CERAMIC JEWELRY**  
**APPLICATION (8)**

## UNILOCK

(The Ultimate Jewelry Element of Personalization)

The “Unilock” as a gem carrier is a barrel shaped tube setting with pre-set gem stones, cabochons or diamonds; designed to be used without the use of solder or adhesives. The Unilock is applied over or into the jewelry at the end of the production cycle using an easy-snap® process with the benefit of delivering urgent last minute orders quickly. The Unilock is utilized by the retailer at their premises to personalize on the spot/over the counter sales of “Mother’s Jewelry”, names or initials, birthstone programs and gifts.

The Unilock setting is produced with a regular barrel, short barrel, straight tube or long barrel and is available in Sterling Silver, 10kt, 14kt, 18kt Gold. This combination of barrel and tube shapes gives the setting unlimited possibilities when installed on various products.



REGULAR

“U”



SHORT

“UX”



STRAIGHT

“UZ”



LONG

“UY”

- **Metals**

GOLD	STAINLESS STEEL	CERAMIC
STERLING SILVER	TITANIUM	TUNGSTEN

- **Jewelry**

CASTING	TURNED	HOLLOW
STAMPED	ELECTROFORM	PHOTOETCH

The advantage of the Unilock is that it simplifies the manufacturing process of the jewelry. It reduces overall cost, creates more flexible inventory-manufacturers can use their own stones; eliminates the need for a skilled jeweler and most importantly: utilizes unparalleled application technology never before available to the jewelry industry. Every gem set into the Unilock has all the desirable features that can be expected from the best stone setters in the industry. The precise positioning of the gem, the minimum amount of metal over the gem, together with the firmness of the stone in its seat; all finished with a mirror polish giving a consistent product appearance and quality. The Unilock is the ultimate, most advanced application system, to set gems into jewelry and gifts today. This application creates new marketing and sales opportunities for the entire industry.

## **UNILOCK APPLICATIONS:**

- 1) Unilock “U” Flush into Gold Jewelry
- 2) Unilock “U” Flush into Cast Gold Jewelry
- 3) Unilock “U” Flush into Sterling Silver Jewelry
- 4) Unilock “U” Flush into Cast Sterling Silver Jewelry
- 5) Unilock “U” Flush into Stainless Steel Jewelry
- 6) Unilock “U” Flush into Titanium Jewelry
- 7) Unilock “U” Flush into Tungsten Jewelry
- 8) Unilock “U” Flush into Ceramic Jewelry**
- 9) Unilock “U” Flush into Enamel Jewelry
- 10) Unilock “U” Flush or Above Pearl Jewelry
- 11) Unilock “U” Above Gold Jewelry
- 12) Unilock “U” Above Cast Gold Jewelry
- 13) Unilock “U” Above Sterling Silver Jewelry
- 14) Unilock “U” Above Cast Sterling Silver Jewelry
- 15) Unilock “U” Above Stainless Steel Jewelry
- 16) Unilock “U” Above Titanium Jewelry
- 17) Unilock “UZ” Above Thin Gold Stamping
- 18) Unilock “UX” Above Sterling Silver Tubing
- 19) Unilock “UX” Above Gold Filled Tubing
- 20) Unilock “UX” Above Hollow Gold
- 21) Unilock “UX” Above Sterling Silver Electroform
- 22) Unilock “UZ” Above Photo Etchings in Gold
- 23) Unilock “U” Flush or “UX” Above Soft & Flexible Materials
- 24) Unilock “U” Flush or Above Wood, Plastic, Composites etc.
- 25) Unilock “U” Flush or Above Aluminum Products

***FOR ALL OTHER APPLICATIONS NOT LISTED ABOVE PLEASE SEND US A SAMPLE TOGETHER WITH YOUR REQUIREMENTS AND OUR R&D DEPT WILL PROVIDE A SET OF INSTRUCTIONS THAT WILL SUIT YOUR NEEDS.***

## UNILOCK REGULAR TUBE APPLICATION (8)

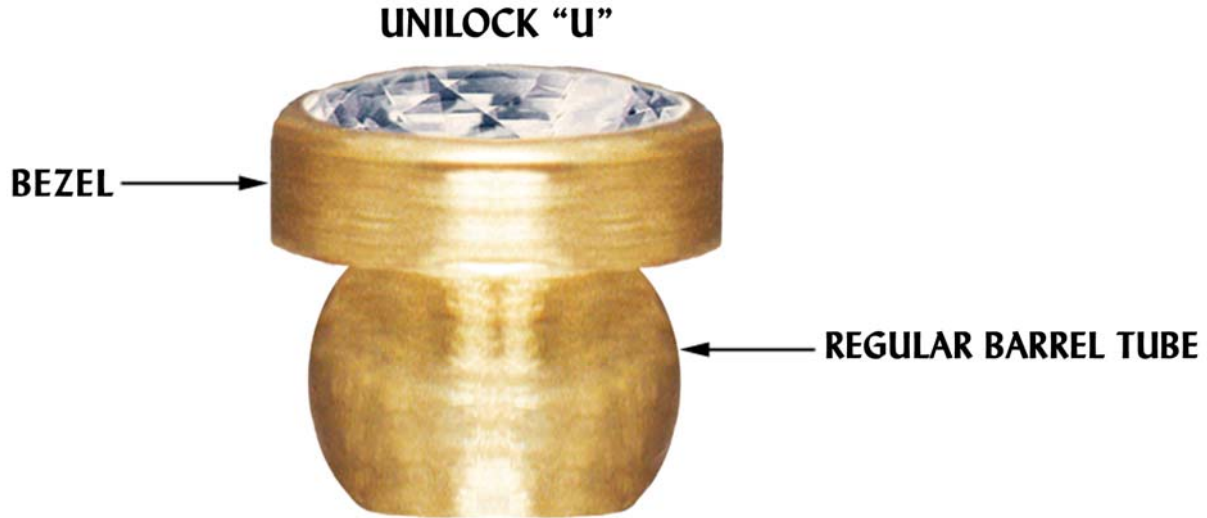

<b>UNILOCK MODEL</b>	<b>REGULAR BARREL TUBE DIAMETER</b>	<b>TUBE HEIGHT</b>	<b>BEZEL</b>	
			<b>DIAMETER</b>	<b>HEIGHT</b>
U160	1.15mm	0.75mm	1.60mm	0.45mm
U190	1.50mm	0.85mm	1.90mm	0.60mm
U240	2.00mm	0.95mm	2.40mm	0.65mm
U290	2.30mm	1.10mm	2.90mm	0.75mm
U350	3.00mm	1.20mm	3.50mm	0.90mm
U420	3.30mm	1.40mm	4.20mm	1.10mm
U530	4.00mm	1.50mm	5.30mm	1.25mm
U630	5.10mm	1.55mm	6.30mm	1.60mm
U750	6.20mm	1.60mm	7.50mm	1.80mm

THE UNILOCK PRESS w/IMPACT TOOL, UNIVERSAL JIG BASE w/JIG SUPPORTS IS UTILIZED BY THE MANUFACTURER TO SIMPLIFY THE ASSEMBLY OF THE UNILOCK AT THE END OF THE PRODUCTION CYCLE.

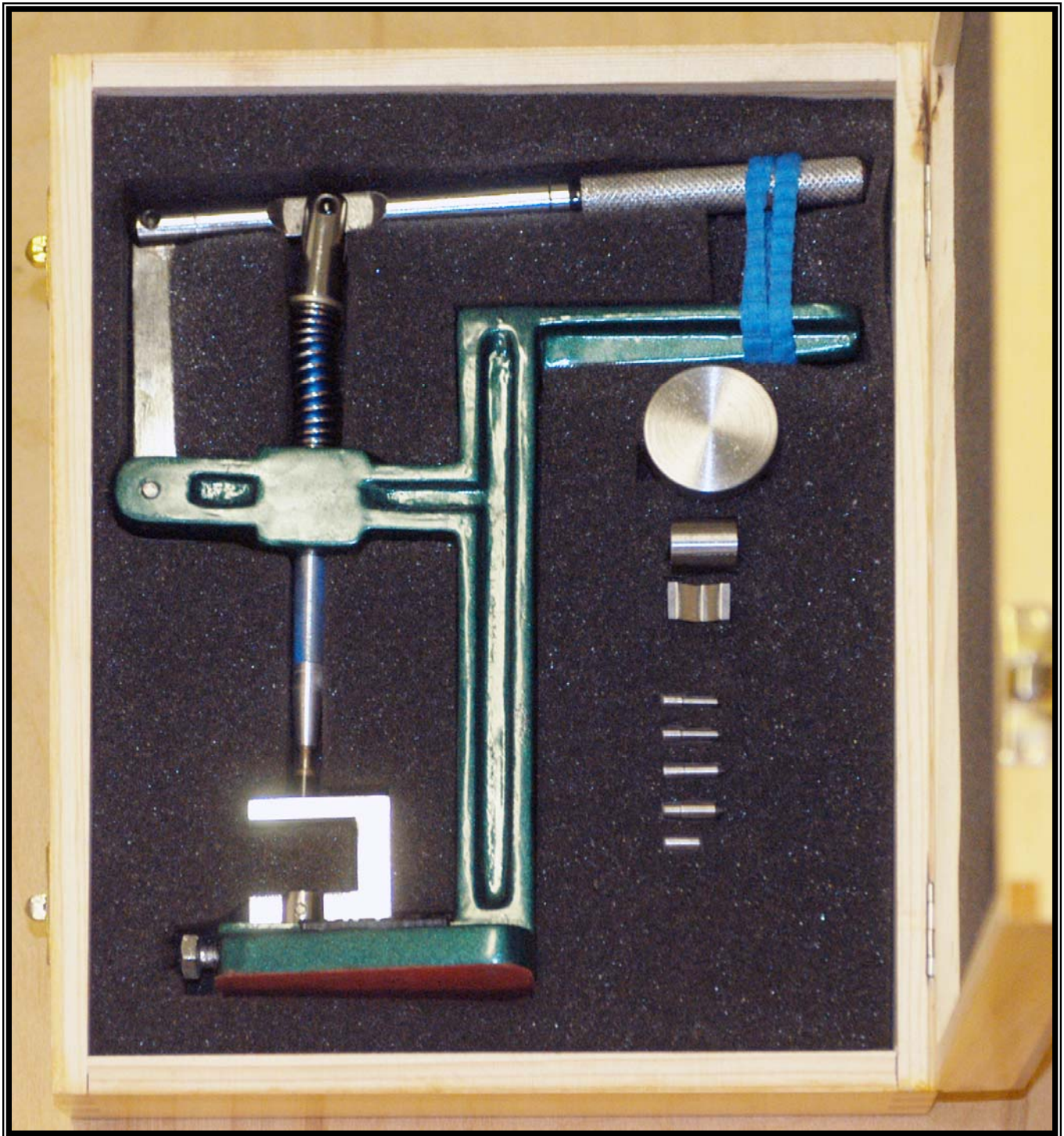

THE UNILOCK PRESS w/IMPACT TOOL, UNIVERSAL JIG BASE w/JIG SUPPORTS IS UTILIZED BY THE RETAILER AT THEIR PREMISES FOR THE PERSONALIZATION OF ON THE SPOT/OVER THE COUNTER SALES OF JEWELRY AND GIFTS.

## **UNILOCK FLUSH INTO CERAMIC JEWELRY APPLICATION (8)**

For the Unilock to sit flush inside the jewelry a two step hole has to be created. Due to the nature of Ceramic the less expensive way to create the hole is to form the same when the casting is made. To create the hole within a tolerance the most critical factor is shrinkage. The percentage of that shrinkage depends mainly on: 1) measuring with precision the quantity of the alloy's components, 2) the system of how to combine them, 3) the mixing order, 4) the time needed to reach the melting point, 5) keeping the alloy at the melting point as per established time, 6) the degree of alloy liquidity before pouring, 7) keep the alloy inside a clean mold surrounded by standard ambiance, 8) the cooling cycle should be controlled by time. Unilock is the only gem carrier that can self adjust to the hole condition and the hole itself does not need to be very precise. We recommend using the caliper Go-No-go before snapping the Unilock into the jewelry [See Page 7](#) To calibrate the casted hole [See Page 8](#)



### **CUSTOMER GEM-STONES USABLE IN UNILOCK**

<b><u>MODEL</u></b>	<b><u>STONE RANGE</u></b>	<b><u>OPTIMAL SIZES</u></b>
U160	1.00mm – 1.30mm	1.20mm – 1.30mm
U190	1.40mm – 1.65mm	1.45mm – 1.55mm
U240	1.70mm – 2.10mm	1.90mm – 2.00mm
U290	2.15mm – 2.55mm	2.40mm – 2.50mm
U350	2.60mm – 3.05mm	2.95mm – 3.05mm
U420	3.10mm – 3.75mm	3.45mm – 3.65mm
U530	3.80mm – 4.70mm	4.00mm – 4.25mm
U630	4.75mm – 5.80mm	4.90mm – 5.40mm
U750	5.90mm – 6.80mm	6.00mm – 6.50mm

The “optimal sizes” are ideal for the Unilock, both for the cosmetic appearance as well as the minimum amount of metal over the gem.



## **UNILOCK FLUSH INTO CERAMIC JEWELRY APPLICATION (8)**

The *Go-No-go* calipers are made using the two extremities of the rod: one end has a small diameter (*go* side) the other end a larger diameter (*no-go* side.) The operator can check in a simple way if the hole is properly executed when the small *go* side enters into the hole and the other *no-go* side cannot enter into the hole.

Two sets of calipers are necessary: the first to check the top part (bezel), the second to check the bottom part (tube.)

### **SIZE OF CALIPERS FOR TOP PART (BEZEL)**

<u>MODEL</u>	<u>GO-DIAMETER</u>	<u>NO-GO DIAMETER</u>
U240	2.45mm	2.50mm
U290	2.95mm	3.00mm
U350	3.55mm	3.60mm
U420	4.25mm	4.30mm
U530	5.35mm	5.40mm
U630	6.35mm	6.40mm
U750	7.55mm	7.60mm

### **SIZE OF CALIPERS FOR BOTTOM PART (TUBE)**

<u>MODEL</u>	<u>GO-DIAMETER</u>	<u>NO-GO DIAMETER</u>
U240	1.94mm	1.97mm
U290	2.24mm	2.27mm
U350	2.94mm	2.97mm
U420	3.24mm	3.27mm
U530	3.94mm	3.97mm
U630	5.04mm	5.07mm
U750	6.14mm	6.17mm

## **UNILOCK FLUSH INTO CERAMIC JEWELRY APPLICATION (8)**

### ***HOW TO CALIBRATE A HOLE INSIDE CERAMIC JEWELRY***

A few new methods are at the experimental stage to calibrate a casted hole inside the ceramic jewelry. The most promising and economical one is to use a steel rod that penetrates inside a casted hole guided by ultrasonic hammering (similar to creating a hole inside a stone.) This concept is based over the theory that ceramic is brittle and its molecular system should collapse rapidly under the ultrasonic hammering action.

### **STEEL ROD SIZE RECOMMENDED**

<b><u>MODEL</u></b>	<b><u>USE ROD DIAMETER</u></b>
U240	1.90mm
U290	2.20mm
U350	2.90mm
U420	3.20mm
U530	3.90mm
U630	5.00mm
U750	6.10mm



**UNILOCK FLUSH INTO CERAMIC JEWELRY APPLICATION (8)**  
**EASY-SNAP®**



**IMPACT TOOL**



**UNILOCK**

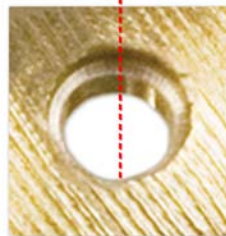

**JEWELRY**

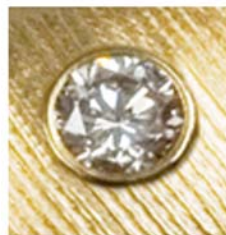

**UNILOCK FLUSH  
INTO JEWELRY**

## IMPACT TOOL

(MODIFIED AUTOMATIC CENTER PUNCH)



### How to Adjust the Impact Tool Pressure:

Calibrate the snap by turning the top screw

- Clockwise = Stronger Snap
- Counter-Clockwise = Weaker Snap

### How to replace the tip:

- 1) Just pull off the tip from the shaft of the impact tool.
- 2) Then push in the new metal tip that you will be using.  
(Replacement tips are available from **Stone Set Technologies**)
- 3) For a tighter fit, a small amount of “**Rodico**” can be used.

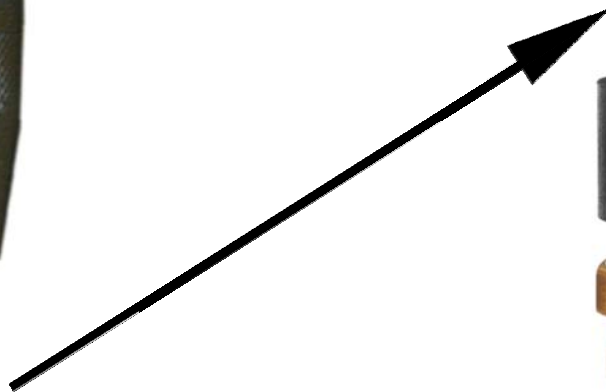

Impact Urethane Tip (IUT)

TO ORDER PARTS, SEE PAGE 16



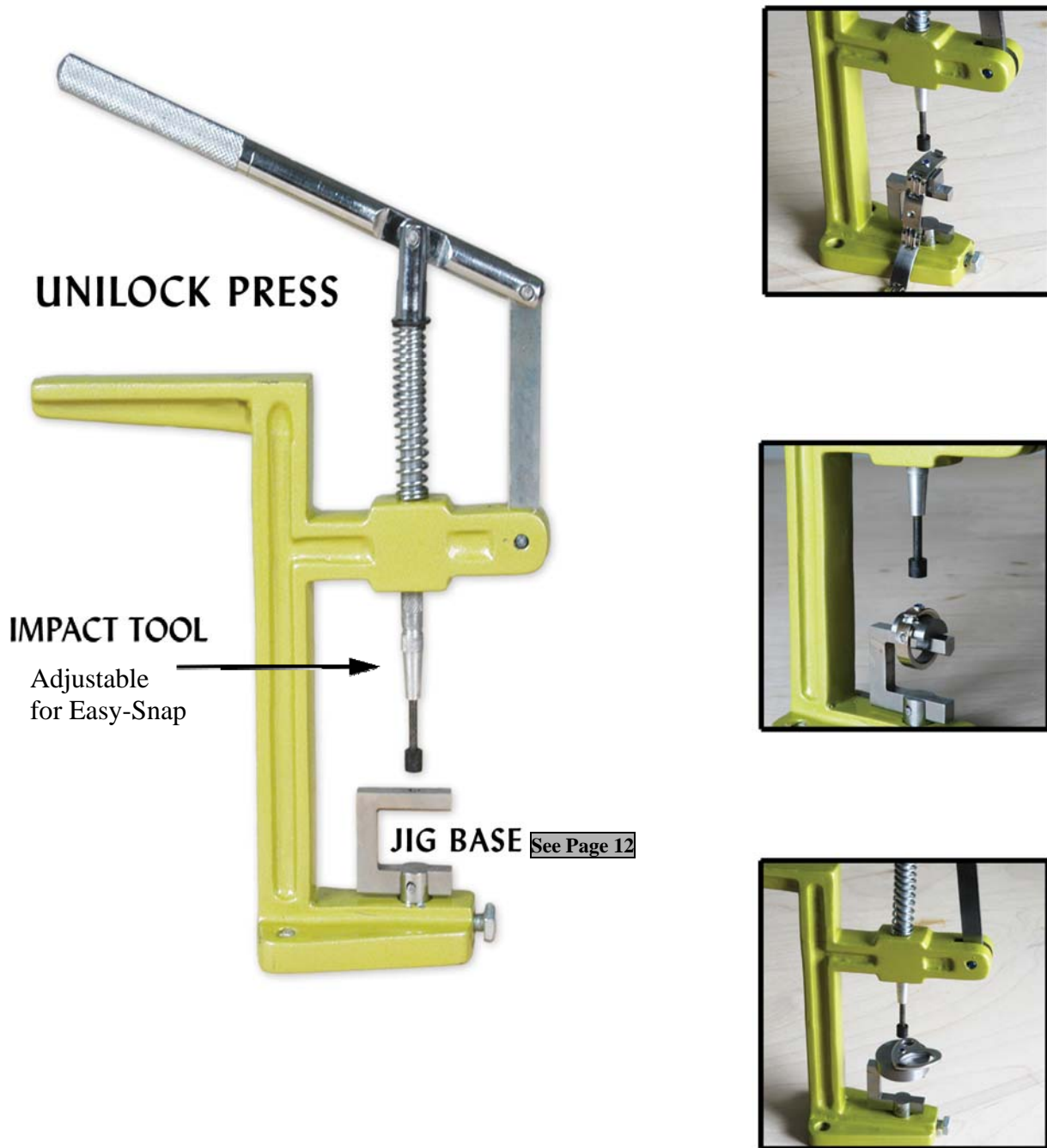

## UNILOCK PRESS WITH IMPACT TOOL AND UNIVERSAL JIG BASE

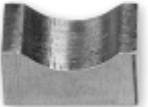

The Unilock Press can be screwed half-way out from the edge of the bench in order to accommodate bangles and other large rounded forms that can rest with their top part over the jig base and the lower part hanging under the press. Jig base supports are needed for this operation.

See next page for a list of jig base supports.

## UNIVERSAL JIG BASE WITH SUPPORTS

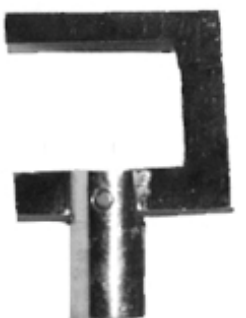
<p>The Unilock Press with the Universal Jig Base and the different supports are designed to accommodate many different jewelry shapes with similar ties to the broad spectrum of geometrical forms: Flat, Round, Cylindrical, Concave, Converse and Asymmetrical. This system can adequately cover 80% of the entire spectrum of shapes. For any different jewelry shape not covered, SST will develop the right support for the customer.</p>		<p>The <u>Centrino</u> series of four inserters is used for irregular forms that are supported directly from the bottom (back side of the jewelry item.) The <u>Centrino</u> penetrates thru the irregular form until reaching the center of the hole where the Unilock will be set and snapped.</p>
		<p>The Concave support is used for round or semi-round forms.</p>
		<p>The half round support is used for rings and other curved forms.</p>
		<p>The flat disc support is used for flat forms, stampings, charms, link bracelets etc.</p>
		<p><u>The reference pin</u> is inserted into the top part of the Jig Base as a receiver for the three large supports.</p>
		<p>The Jig Base is U-shaped to accommodate the bottom of a ring shank, bracelet or any large tube earring.</p>

## UNILOCK PRESS FOR EASY-SNAP® WITH INCLINABLE HOLDER

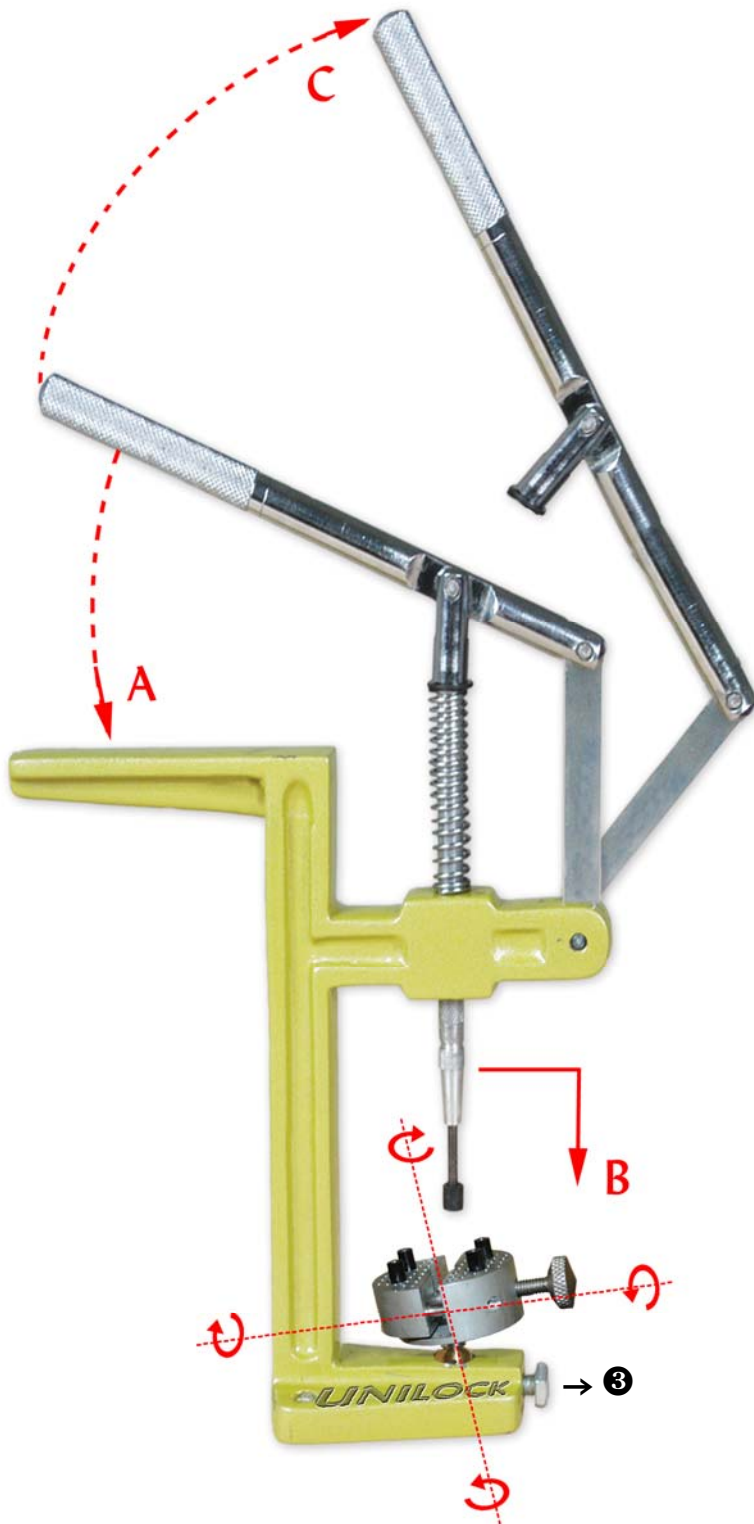

### How to remove the Impact Tool:

- A - Press the Lever all the way down.
  - B - Hold the bottom shaft of the Impact Tool.
  - C - Pull the lever handle all the way up and away.
- Now you can Pull the Impact Tool up and out from the press.

### How to insert Inclinable Holder:

- 1) Insert Ball into hole in base of press all the way down.
- 2) Adjust Inclination.
- 3) Secure by tightening lock screw clockwise.

**INCLINABLE MODIFIED HOLDER FOR UNILOCK PRESS**

Modified Holder Urethane Protector (MUP)

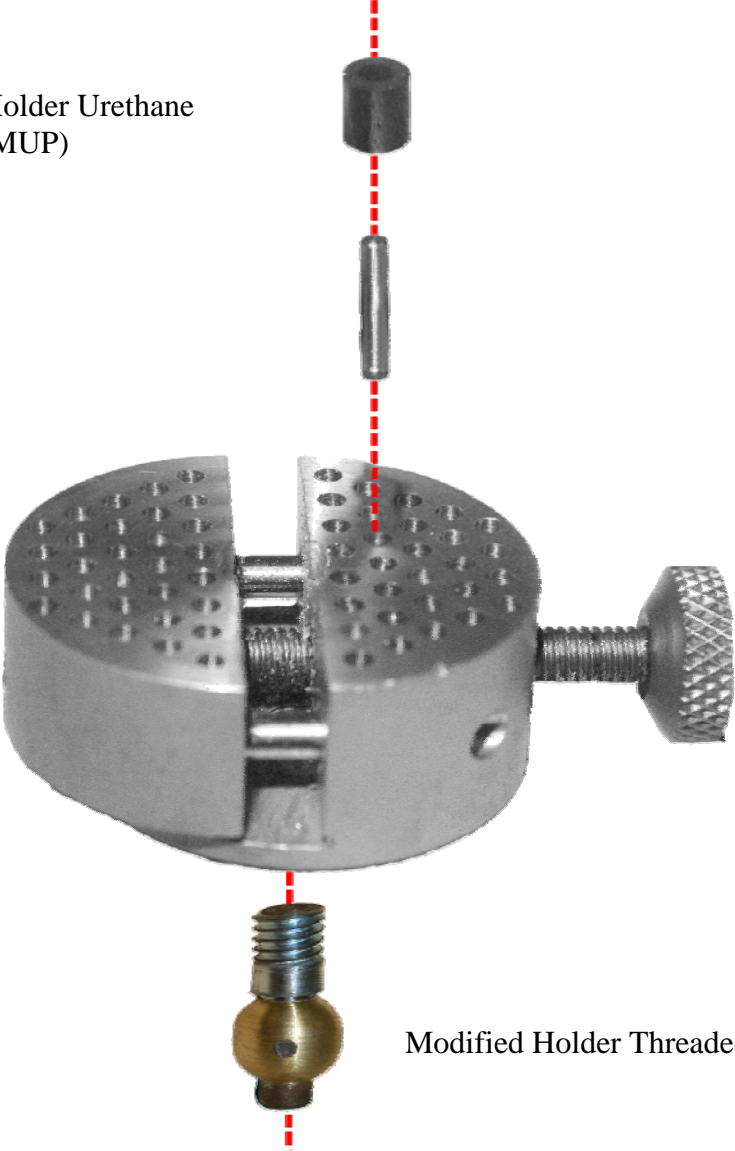

Modified Holder Threaded Ball (MTB)

TO ORDER PARTS, SEE PAGE 16

**UNILOCK ORDER SHEET**

<b><u>Month</u></b>	<b>Birthstone</b>	<b>Gem Size</b>	<b>Unilock Model</b>	<b>Type of Metal</b>	<b>Application</b>	<b>Tube Type</b>	<b>Quantity</b>
<b>January</b>							
<b>February</b>							
<b>March</b>							
<b>April</b>							
<b>May</b>							
<b>June</b>							
<b>July</b>							
<b>August</b>							
<b>September</b>							
<b>October</b>							
<b>November</b>							
<b>December</b>							

<b>Other Gems and Diamonds</b>	<b>Gem Size</b>	<b>Unilock Model</b>	<b>Type of Metal</b>	<b>Application</b>	<b>Tube Type</b>	<b>Quantity</b>

**ORDER DELIVERY TIME**

Unilock samples are delivered within one week's time as per stock availability.

Orders of Unilock in Sterling Silver are delivered within 3-4 weeks after customer stones are received.

Orders of Unilock **U160, U190, U240, U290 & U350** made in 14kt yellow gold are delivered within 3-4 weeks after customer stones are received.

Orders of Unilock **U160, U190, U240, U290 & U350** of different gold karatages and colors are delivered within 6-8 weeks.

Orders of Unilock **U420, U530, U630 & U750** of any karatage and color are subject to minimum quantities and are delivered within 6-8 weeks.



## **UNILOCK PRODUCTION SUPPORT APPLICATION (8)**

### **AVAILABLE FROM STONE SET TECHNOLOGIES**

- 1) The *Unilock Press and Impact Tool* with Universal Jig Base and jig supports – Pages 5, 11, 12 - are provided to Unilock users at cost. This service is provided only to our customers.
- 2) *Impact Tool* – page 10
- 3) *Impact Tool Urethane tip replacement (IUT)* – page 10
- 4) *Inclinable Modified Holder Parts* – page 14
  - a) Holder Urethane Protector (MUP)
  - b) Hardened Holder Threaded Ball (MTB)

### **AVAILABLE DIRECTLY FROM INDIVIDUAL VENDORS**

- 5) *Inclinable Modified Holder* (universal work holder w/pegs) – page 14:  
Rio Grande #113-089 [www.riogrande.com](http://www.riogrande.com) 1.800.545.6566

### **STONE SET TECHNOLOGIES LLC.**

**TEL: 954.565.4979**

**TOLL FREE: 888.201.3586**

**FAX: 954.565.4931**

**MAIL:**

P.O. BOX 48020

FT. LAUDERDALE, FL 33348

**DELIVERIES:**

3532 N. OCEAN BLVD. 2<sup>ND</sup> FLOOR

FT. LAUDERDALE, FL 33308

[WWW.UNILOCK.US](http://WWW.UNILOCK.US)